

COMPONENT GUIDE: GARDEN BOLLARDS

Pole with Spike Unit: The bollard is connected to the adapter using standard plugs delivered with the fixture. Length of enclosed cables: 5m. Put the spike into the ground and let the enclosed cables run over the ground. *Plug and play.*

Pole with anchor unit: Fixed in concrete. Use installation cable. Installed by a certified installer.

Pole with baseplate: For surface mounting. Use installation cable. Installed by certified installer.

Note:

The adapter is positioned externally from the bollard. Maximum distance to last bollard is 30m.

Bysted: The adapter can run up to 4 bollards.

Flindt: The adapter can run up to 6 bollards.

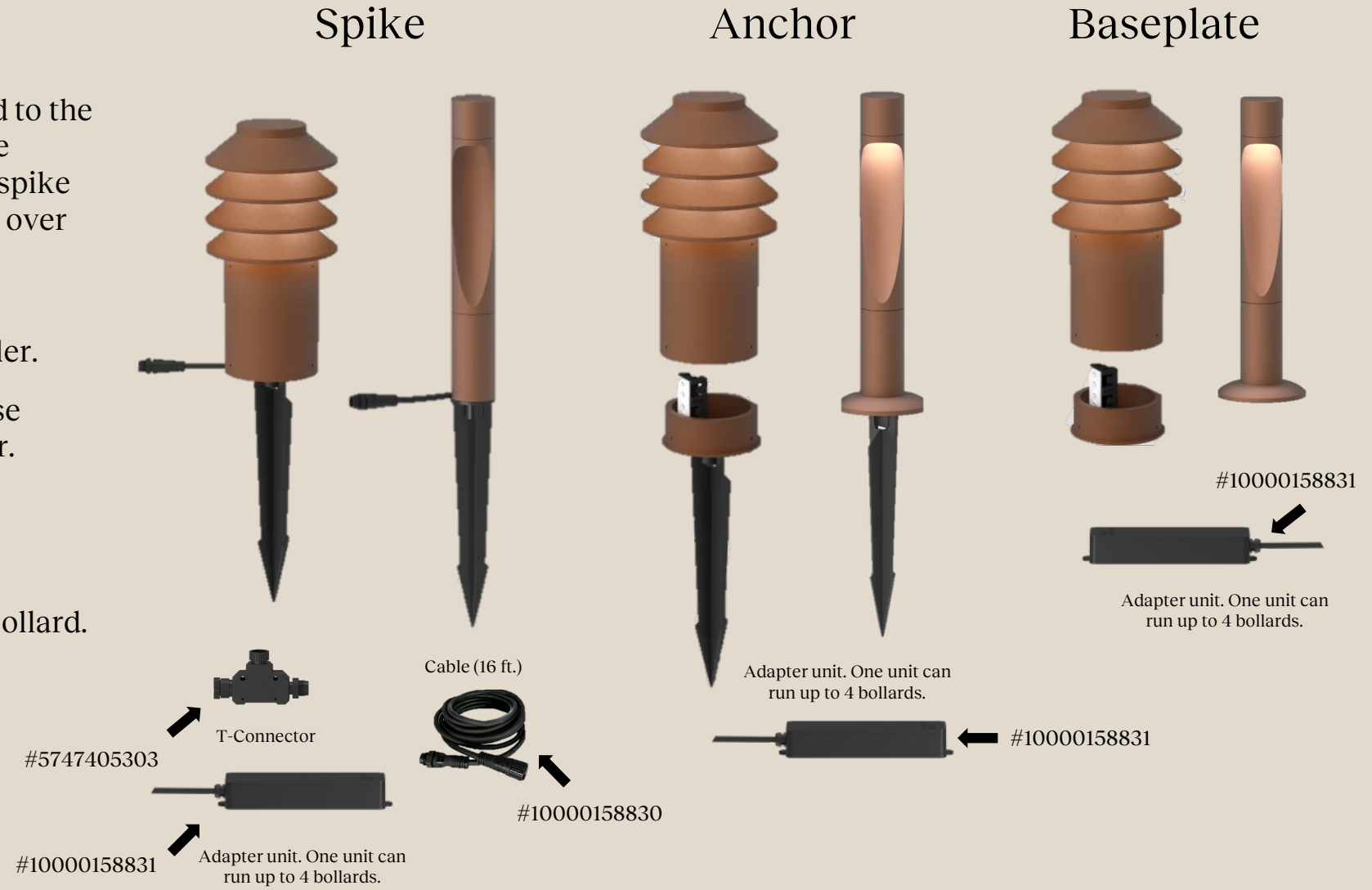

HOW TO ORDER:

For Spike Variants:

Power supply, purchased separately, includes a plug for a standard US outlet and 5-foot cable to connect to bollards. Power kit sku #10000158965.

10000158965 consists of below, which automatically is added to the order when ordering 10000158965:

10000158830 - DRVR CV 100W UNI 24VDC CORDS + PLUGS

10000158831 - MI US GARDEN POWER SUPPLY 100W W-CONN

For Anchor & Baseplate:

Power supply, purchased separately, with glands for electrician-provided conduit. The power supply runs on 120-277V input. Power kit sku #10000158964.

10000158964 consists of below, which automatically is added to the order when ordering 10000158964:

10000156739 - DRVR CV 100W UNI 24VDC CONDUIT ENTRY OUT

10000156764 - MI US GARDEN POWER SUPPLY 100W 24VDC



FLINDT GARDEN BOLLARD

SHORT / LED 2700K 6.5W / 24V / Black texture / - / Anchor w/o power supply / - / 5747408889

The fixture emits a wide downward directed glare-free light. The light source rests at the top inside the asymmetric carving on the side of the bollard, where the gradient serves as a reflector that softens the light and forms a pleasant organic shape on the ground below.



Christian Flindt

Christian Flindt (1972-) graduated with an MAA and MDD from Aarhus School of Architecture in 2002. He then started his own design company in 2003. Here, he placed high emphasis on communication between people, and his focus on this area finds expression in his approach to re-evaluating furniture.



Product info

Environmental Product Specification

This product is compliant with the requirements contained in the European Directives, RoHS Directive 2011/65 and 2015/863. This product is designed so that 100% of the product can be disassembled and reused.

Information

Electrical: System Wattage: 6.5W LED Wattage: 6.0W Delivered lumens: 215-291 lm Efficacy: 33.1 - 44.7 lm/W
 Certifications: cULus, Wet Location Protection class IP65 IK class 06 BUG Rating: B0-U2-G0 Color Rendering: Ra>80 LED is non-dimming. Low Voltage power supply 24VDC is remote mounted for multiple bollards per supply. Spike mounted bollards use provided weather-proof cables and connectors for above-ground runs. Plug and play. Anchor or Base mounted bollards: installation determined by certified electrician with below ground cabling and conduit. Consult factory for remote power supply information; maximum bollards and cable distances.

Mounting

The bollard requires a separate, 24V DC power supply. Choice of 3 different mounting types. Spike mounted bollard(Plug&Play): For use in soil or gravel; includes weather-proof cables and connectors for above-ground runs. Anchor mounted bollard(certified electrician): for casting in new concrete pad. Base mounted bollard(certified electrician): Includes baseplate for anchoring to decks and floors. Anchor or Base mounted bollards: installation determined by certified electrician with below ground cabling and conduit.

Finish

Natural painted aluminum or corten colored. Textured surface, powder coated.

Materials

Top: Cast aluminum. Reflector part: Cast aluminum. Post: Extruded aluminum. Base plate: Cast aluminum.

Sizes and weight

Width x Height x Length (in.) | 2 x 27.5 x 2 Max 4.9 lbs | 2 x 13.7 x 2 Max 5.2 lbs | 2 x 37.8 x 2 Max 5.4 lbs

Compliance

cULus, Wet location.

Light source

LED 2700K 6.5W

Information

Electrical:

System Wattage: 6.5W

LED Wattage: 6.0W

Delivered lumens: 215-291 lm

Efficacy: 33.1 - 44.7 lm/W

Certifications:

cULus, Wet Location

Protection class IP65

IK class 06

BUG Rating: B0-U2-G0

Color Rendering: Ra>80

LED is non-dimming.

Low Voltage power supply 24VDC is remote mounted for multiple bollards per supply. Spike mounted bollards use provided weather-proof cables and connectors for above-ground runs. Plug and play.

Anchor or Base mounted bollards: installation determined by certified electrician with below ground cabling and conduit. Consult factory for remote power supply information; maximum bollards and cable distances.



Related products



Flindt Bollard

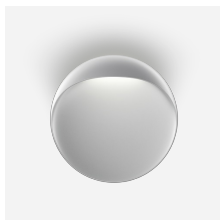

Flindt Wall

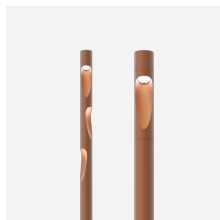

Flindt Plaza

Spare parts & accessories

Product	Variant number
Power Supply for Base & Anchor Mount, 24VDC 100W 120-277V Input	10000158964
Power Supply with Cords for Spike Mount, 24VDC 100W 120V Input	10000158965

Data specifications

Colour	Black texture	Length	2
Width	2	Height	13.7
IP class	-	IK class	-
Class	-	Net Weight	2.2
Wind Load (ft2)	-	Standby (W)	-
Power Factor (P = 100 % / P = 50 %)	-	Inrush Current	-
Light source	LED 2700K 6.5W	Kelvin	2700
CRI	-	SDCM	-
Lumen	-	Watt	6.5
Efficacy	-	Light control	-
Min. Dim Level (%)	-	Surges	-
BUG Rating	-	L80B50 (hours)	-
Driver life	-		

FLINDT GARDEN BOLLARD

Designed by Christian Flindt

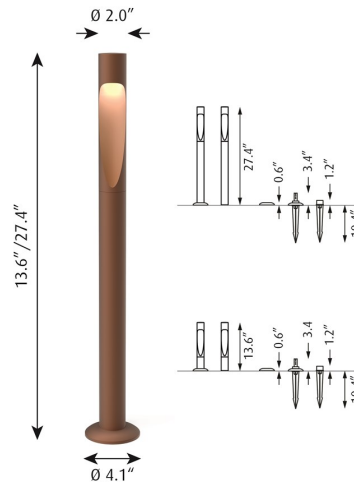

Description

The fixture emits a wide downward directed glare-free light. The light source rests at the top inside the asymmetric carving on the side of the bollard, where the gradient serves as a reflector that softens the light and forms a pleasant organic shape on the ground below.

Variants

VARIANT NUMBER	COLOR, RAL	W / H / L (IN) / W (LB)
10000158330	NAT PAINT ALU, 162	- / - / - IN / 5.2 LB
10000158331	CORTEN COLOR, 954	- / - / - IN / 5.2 LB
10000158332	NAT PAINT ALU, 162	- / - / - IN / 5.2 LB
10000158333	CORTEN COLOR, 954	- / - / - IN / 5.2 LB
10000158334	NAT PAINT ALU, 162	- / - / - IN / 5.2 LB
10000158335	CORTEN COLOR, 954	- / - / - IN / 5.2 LB
10000158336	NAT PAINT ALU, 162	- / - / - IN / 5.2 LB
10000158337	CORTEN COLOR, 954	- / - / - IN / 5.2 LB
10000158338	NAT PAINT ALU, 162	- / - / - IN / 5.2 LB
10000158339	CORTEN COLOR, 954	- / - / - IN / 5.2 LB
10000158340	NAT PAINT ALU, 162	- / - / - IN / 5.2 LB
10000158341	CORTEN COLOR, 954	- / - / - IN / 5.2 LB
5747402461	CORTEN COLOR, 954	2 / 13.7 / 2 IN / 2.8 LB
5747402474	CORTEN COLOR, 954	2 / 13.7 / 2 IN / 2.8 LB
5747402487	CORTEN COLOR, 954	2 / 13.7 / 2 IN / 2.8 LB
5747402490	CORTEN COLOR, 954	2 / 13.7 / 2 IN / 3.2 LB
5747402500	CORTEN COLOR, 954	2 / 13.7 / 2 IN / 3.2 LB
5747402513	CORTEN COLOR, 954	2 / 13.7 / 2 IN / 5.2 LB

5747402555	CORTEN COLOR, 954	2 / 27.5 / 2 IN / 2.9 LB
5747402568	CORTEN COLOR, 954	2 / 27.5 / 2 IN / 2.9 LB
5747402571	CORTEN COLOR, 954	2 / 27.5 / 2 IN / 2.9 LB
5747402584	CORTEN COLOR, 954	2 / 37.8 / 2 IN / 3.4 LB
5747402597	CORTEN COLOR, 954	2 / 37.8 / 2 IN / 3.4 LB
5747402607	CORTEN COLOR, 954	2 / 37.8 / 2 IN / 5.4 LB
5747402827	NAT PAINT ALU, 162	2 / 13.7 / 2 IN / 4.7 LB
5747402830	NAT PAINT ALU, 162	2 / 13.7 / 2 IN / 2.8 LB
5747402843	NAT PAINT ALU, 162	2 / 13.7 / 2 IN / 2.8 LB
5747402856	NAT PAINT ALU, 162	2 / 13.7 / 2 IN / 5.2 LB
5747402869	NAT PAINT ALU, 162	2 / 13.7 / 2 IN / 5.2 LB
5747402872	NAT PAINT ALU, 162	2 / 13.7 / 2 IN / 3.2 LB
5747402911	NAT PAINT ALU, 162	2 / 27.5 / 2 IN / 4.9 LB
5747402924	NAT PAINT ALU, 162	2 / 27.5 / 2 IN / 2.9 LB
5747402937	NAT PAINT ALU, 162	2 / 27.5 / 2 IN / 2.9 LB
5747402940	NAT PAINT ALU, 162	2 / 37.8 / 2 IN / 3.4 LB
5747402953	NAT PAINT ALU, 162	2 / 37.8 / 2 IN / 3.4 LB
5747402966	NAT PAINT ALU, 162	2 / 37.8 / 2 IN / 3.4 LB
5747408779	BLK, 731	- / - / - IN / 3.2 LB
5747408782	BLK, 731	- / - / - IN / 3.2 LB
5747408795	BLK, 731	- / - / - IN / 3.2 LB
5747408805	BLK, 731	- / - / - IN / 4.0 LB
5747408818	BLK, 731	- / - / - IN / 4.0 LB
5747408821	BLK, 731	- / - / - IN / 4.0 LB
5747408834	BLK, 731	2 / 13.7 / 2 IN / 2.1 LB
5747408847	BLK, 731	2 / 13.7 / 2 IN / 2.1 LB
5747408850	BLK, 731	2 / 13.7 / 2 IN / 2.1 LB
5747408863	BLK, 731	2 / 13.7 / 2 IN / 2.2 LB
5747408876	BLK, 731	2 / 13.7 / 2 IN / 2.2 LB
5747408889	BLK, 731	2 / 13.7 / 2 IN / 2.2 LB
5747408892	BLK, 731	2 / 13.7 / 2 IN / 3.1 LB
5747408902	BLK, 731	2 / 13.7 / 2 IN / 3.1 LB
5747408915	BLK, 731	2 / 13.7 / 2 IN / 3.1 LB
5747408928	BLK, 731	2 / 27.5 / 2 IN / 2.9 LB
5747408931	BLK, 731	2 / 27.5 / 2 IN / 2.9 LB
5747408944	BLK, 731	2 / 27.5 / 2 IN / 2.9 LB
5747408957	BLK, 731	2 / 37.8 / 2 IN / 3.1 LB
5747408960	BLK, 731	2 / 37.8 / 2 IN / 3.1 LB
5747408973	BLK, 731	2 / 37.8 / 2 IN / 3.1 LB
5747408986	BLK, 731	2 / 37.8 / 2 IN / 3.9 LB
5747408999	BLK, 731	2 / 37.8 / 2 IN / 3.9 LB
5747409008	BLK, 731	2 / 37.8 / 2 IN / 3.9 LB

Materials & Finishes

MATERIALS

Top: Cast aluminum. Reflector part: Cast aluminum. Post: Extruded aluminum. Base plate: Cast aluminum.

FINISHES

Natural painted aluminum or corten colored. Textured surface, powder coated.

Mounting

The bollard requires a separate, 24V DC power supply.

louis poulsen

Choice of 3 different mounting types.

Spike mounted bollard(Plug&Play): For use in soil or gravel; includes weather-proof cables and connectors for above-ground runs.

Anchor mounted bollard(certified electrician): for casting in new concrete pad.

Base mounted bollard(certified electrician): Includes baseplate for anchoring to decks and floors.

Anchor or Base mounted bollards: installation determined by certified electrician with below ground cabling and conduit. For mounting instructions, see download section on the product detail page.

Information

Electrical:

System Wattage: 6.5W

LED Wattage: 6.0W

Delivered lumens: 215-291 lm

Efficacy: 33.1 - 44.7 lm/W

Certifications:

cULus, Wet Location

Protection class IP65

IK class 06

BUG Rating: B0-U2-G0

Color Rendering: $R_a \geq 80$

LED is non-dimming.

Low Voltage power supply 24VDC is remote mounted for multiple bollards per supply. Spike mounted bollards use provided weather-proof cables and connectors for above-ground runs. Plug and play.

Anchor or Base mounted bollards: installation determined by certified electrician with below ground cabling and conduit. Consult factory for remote power supply information; maximum bollards and cable distances. For the E-socket product variants, bulbs are not included. LED light source is part of the product.

Light distribution diagrams

CARTESIAN

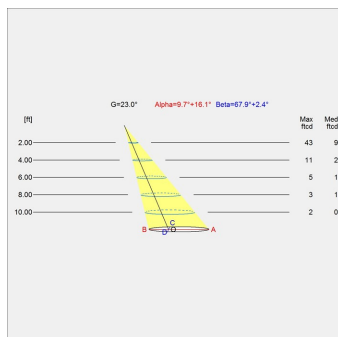

ISOLUX

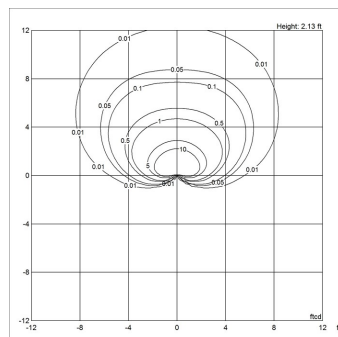

POLAR

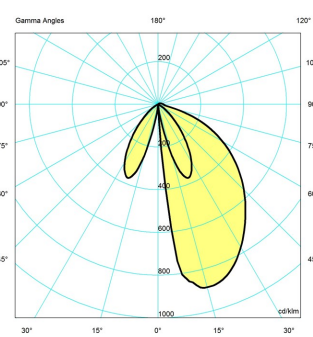

BUG

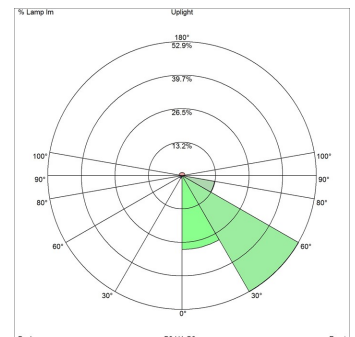

louis poulsen

Variant Options For particular variant options, please check our online Product Variants Configurator on the product detail page.

VARIANT NO.	LIGHT SOURCE	VOLTAGE/FRQ	LUMEN	FEATURES	CABLE
10000158330	LED 3000K 6.5W	24V	252	-	-
10000158331	LED 3000K 6.5W	24V	215	-	-
10000158332	LED 4000K 6.5W	24V	291	-	-
10000158333	LED 4000K 6.5W	24V	248	-	-
10000158334	LED 2700K 6.5W	24V	252	-	-
10000158335	LED 2700K 6.5W	24V	215	-	-
10000158336	LED 3000K 6.5W	24V	252	-	-
10000158337	LED 3000K 6.5W	24V	215	-	-
10000158338	LED 4000K 6.5W	24V	291	-	-
10000158339	LED 4000K 6.5W	24V	248	-	-
10000158340	LED 2700K 6.5W	24V	252	-	-
10000158341	LED 2700K 6.5W	24V	215	-	-
5747402461	LED 4000K 6.5W	24V	248	-	-
5747402474	LED 3000K 6.5W	24V	215	-	-
5747402487	LED 2700K 6.5W	24V	215	-	-
5747402490	LED 4000K 6.5W	24V	248	-	-
5747402500	LED 3000K 6.5W	24V	215	-	-
5747402513	LED 2700K 6.5W	24V	215	-	-
5747402555	LED 4000K 6.5W	24V	248	-	-
5747402568	LED 3000K 6.5W	24V	215	-	-
5747402571	LED 2700K 6.5W	24V	215	-	-
5747402584	LED 4000K 6.5W	24V	248	-	-
5747402597	LED 3000K 6.5W	24V	215	-	-
5747402607	LED 2700K 6.5W	24V	215	-	-
5747402827	LED 4000K 6.5W	24V	291	-	-
5747402830	LED 3000K 6.5W	24V	252	-	-
5747402843	LED 2700K 6.5W	24V	252	-	-
5747402856	LED 4000K 6.5W	24V	291	-	-
5747402869	LED 3000K 6.5W	24V	252	-	-
5747402872	LED 2700K 6.5W	24V	252	-	-
5747402911	LED 4000K 6.5W	24V	291	-	-
5747402924	LED 3000K 6.5W	24V	252	-	-
5747402937	LED 2700K 6.5W	24V	252	-	-
5747402940	LED 4000K 6.5W	24V	291	-	-
5747402953	LED 3000K 6.5W	24V	252	-	-
5747402966	LED 2700K 6.5W	24V	252	-	-
5747408779	LED 4000K 6.5W	24V		-	-
5747408782	LED 3000K 6.5W	24V		-	-
5747408795	LED 2700K 6.5W	24V		-	-
5747408805	LED 4000K 6.5W	24V		-	-
5747408818	LED 3000K 6.5W	24V		-	-
5747408821	LED 2700K 6.5W	24V		-	-
5747408834	LED 4000K 6.5W	24V		-	-
5747408847	LED 3000K 6.5W	24V		-	-
5747408850	LED 2700K 6.5W	24V		-	-
5747408863	LED 4000K 6.5W	24V		-	-
5747408876	LED 3000K 6.5W	24V		-	-
5747408889	LED 2700K 6.5W	24V		-	-
5747408892	LED 4000K 6.5W	24V		-	-
5747408902	LED 3000K 6.5W	24V		-	-
5747408915	LED 2700K 6.5W	24V		-	-
5747408928	LED 4000K 6.5W	24V		-	-

louis poulsen

5747408931	LED 3000K 6.5W	24V	-	-
5747408944	LED 2700K 6.5W	24V	-	-
5747408957	LED 4000K 6.5W	24V	-	-
5747408960	LED 3000K 6.5W	24V	-	-
5747408973	LED 2700K 6.5W	24V	-	-
5747408986	LED 4000K 6.5W	24V	-	-
5747408999	LED 3000K 6.5W	24V	-	-
5747409008	LED 2700K 6.5W	24V	-	-
